

Armaton 3000 XF

Armaton 3000 XF – a weight-optimized dropside lock system for the maximum possible payload for vehicles with a load capacity of up to 6000 kg. The system is easy to use, durable and ergonomic.

The unique 160 degrees action of the handle and 37 mm dimension in open position reduce the risk of the handle making contact with items, e.g. toolboxes, under the platform. The handle is also replaceable.

With a frame of anodized aluminum and in-depth component parts of the highest quality, the product is to all intents and purposes maintenance-free.

The Armaton 3000 XF is available in three standard dropside heights: 300, 350 and 400 mm.

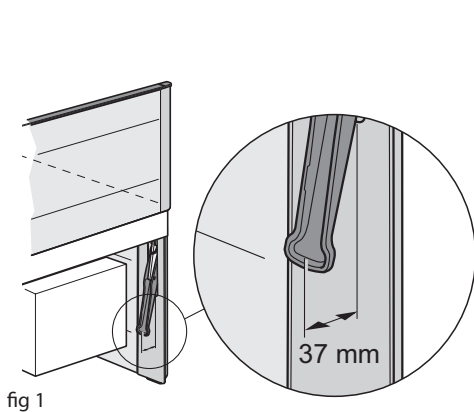

fig 1

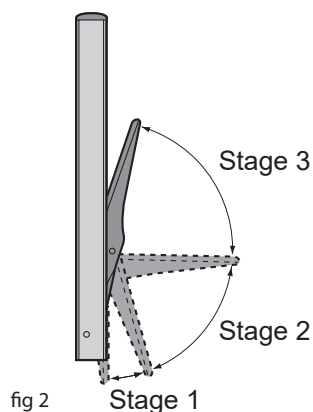

fig 2

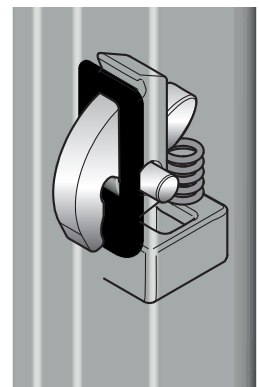

fig 3

Unique handle action

A minimum space of 37 mm is required when lowering the dropside thanks to the unique 160° handle action, see fig 1.

Replaceable handles, reduced maintenance

A special handle kit is available as a spare part, for easy replacement.

Enhanced safety

The locking mechanism has a three-stage action to improve safety.

- Stage 1: Balanced position
- Stage 2: The lock hook is not actuated, clearance
- Stage 3: The lock hook opens, see fig 2.

No freeplay, great gathering ability

The latch is spring-loaded so that together with the wear plate, it takes up all the freeplay in all directions between the pillar and dropside.

The design is optimized for the greatest possible gathering ability. This gives a simple, smooth and distinct locking action, see fig 3.

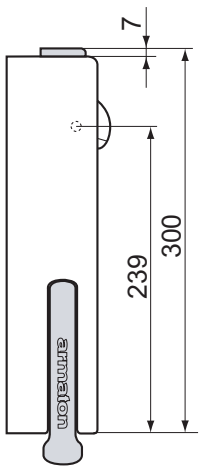

Pillar, 300 mm, right

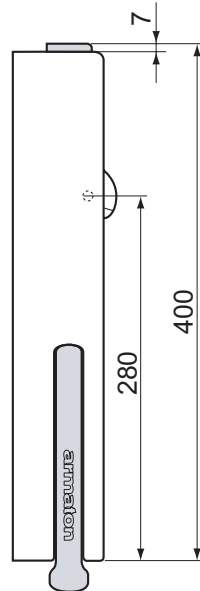
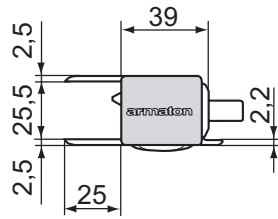
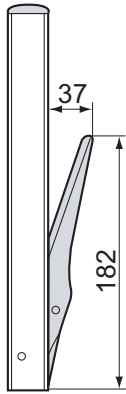

Pillar, 400 mm, right

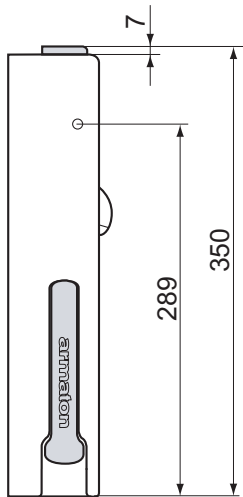
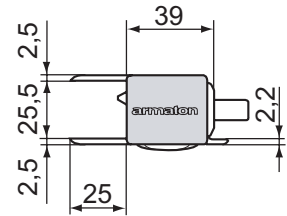
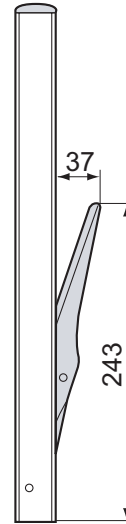

Pillar, 350 mm, right

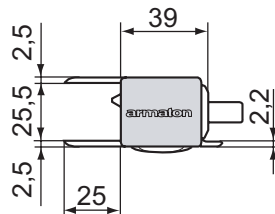
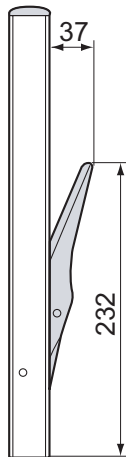

Specification

Description	Weight	Part no
300 mm dropside height:		
Lock, left 300 mm	0,55 kg	510110016
Lock, right 300 mm	0,55 kg	510110017
350 mm dropside height:		
Lock, left 350 mm	0,60 kg	510110020
Lock, right 350 mm	0,60 kg	510110021
400 mm dropside height:		
Lock, left 400 mm	0,68 kg	510110003
Lock, right 400 mm	0,68 kg	510110004

Armaton 3000 XF is tested in accordance with European Standard EN 12642 for vehicles up to a loading capacity of 6000 kg.

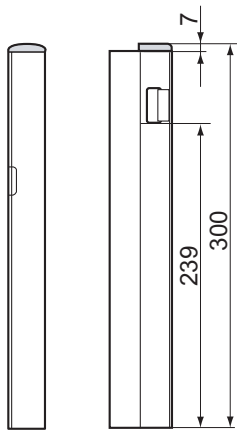

Edge cap, 300 mm, right

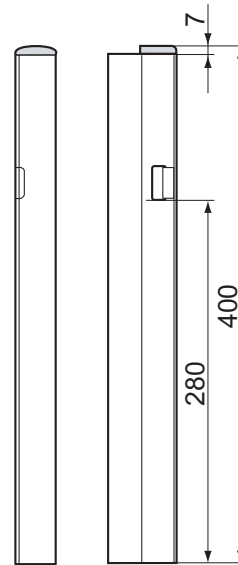
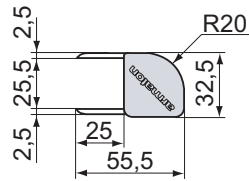

Edge cap, 400 mm, right

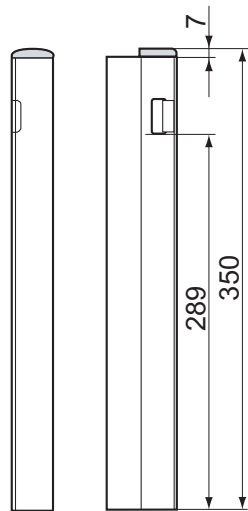
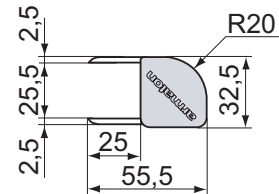

Edge cap, 350 mm, right

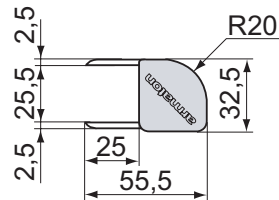

Specification

Description	Weight	Part no	Comment
300 mm dropside height:			
Edge cap, left 300 mm	0,28 kg	510110019	Fits dropside 510110016
Edge cap, right 300 mm	0,28 kg	510110018	Fits dropside 510110017
350 mm dropside height:			
Edge cap, left 350 mm	0,33 kg	510110023	Fits dropside 510110020
Edge cap, right 350 mm	0,33 kg	510110022	Fits dropside 510110021
400 mm dropside height			
Edge cap, left 400 mm	0,37 kg	510110008	Fits dropside 510110003
Edge cap, right 400 mm	0,37 kg	510110007	Fits dropside 510110004

Armaton 3000 XF is tested in accordance with European Standard EN 12642 for vehicles up to a loading capacity of 6000 kg.

FORANKRA AB

Box 100

SE-447 23 Vårgårda, Sweden

Tel +46 322 66 78 00